

VELUX E-CLASS user manual

Solar powered motorized venting

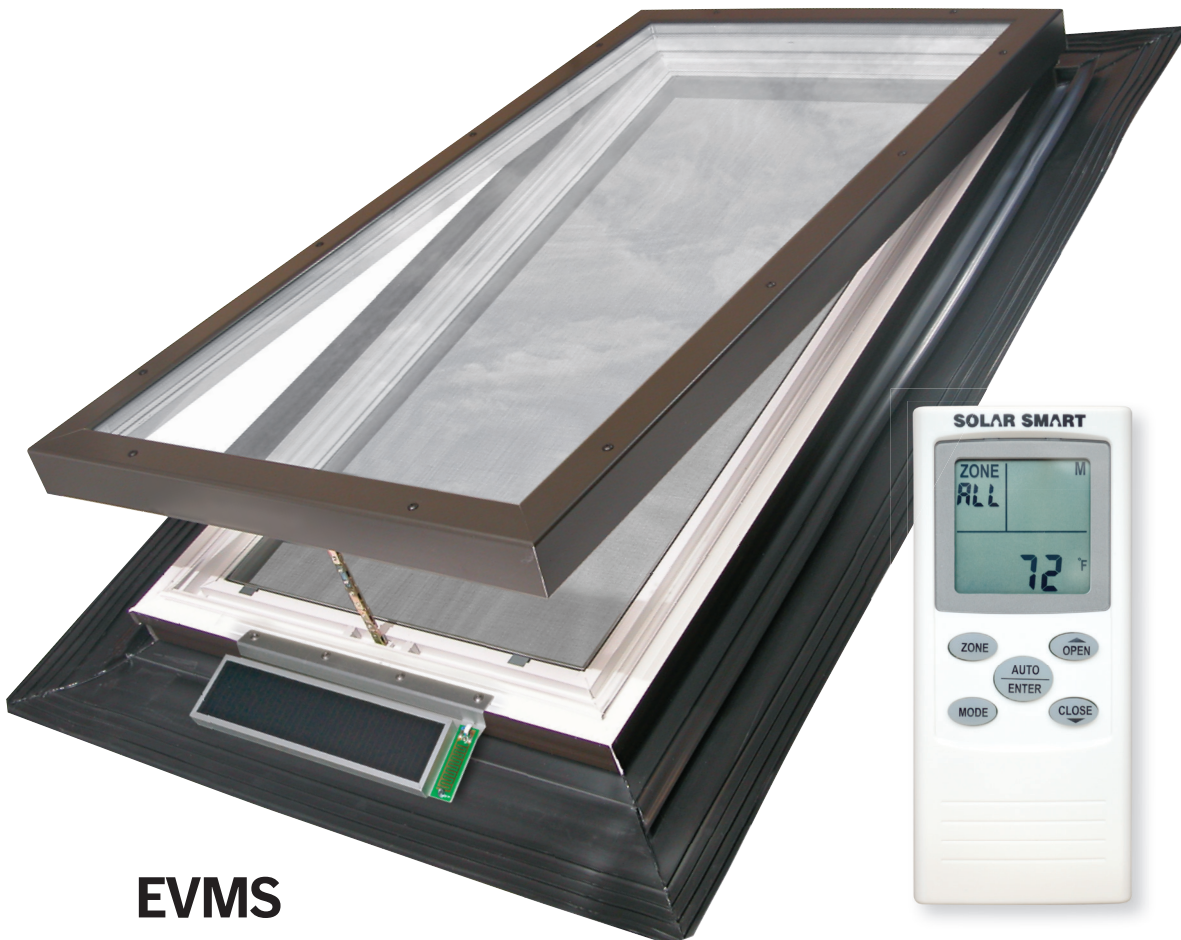

EVMS

TABLE OF CONTENTS

- 3 In The Box
- 4 Basic Operation
- 5 Remote Setup and Configuration
- 6 Pairing Remote to Operator
- 7 Multiple Remotes
- 8 Secondary Remote Configuration
- 9 Rain Sensor Operation
- 10 Time to Close Operation
- 1 Setting MAX-OPEN Limit
- 12 Setting Temperature Control (TC)
- 13 Checking STATUS of Batteries and Charging Current
- 14 Re-Zoning
- 15 Remote Display
- 16 Troubleshooting Tips

FEATURES

Operator Highlights:

1. Powered by a solar charged NiMH battery pack.
2. End-user replaceable battery pack.
3. Operating force rating of 60 lbs at the chain.
4. Maximum opener chain travel of 8 inches with option to program various lengths.
5. Bright White cover standard. Paintable surface for custom color match.
6. Attachment link on chain is fastened to the sash by a release pin.
7. AC trickle charger included.
8. Adaptable to awning and hopper windows, and skylights.

Remote Highlights:

1. Large and readable display with bi-directional feedback from the operator:
 - a. Open / Close status percentage displayed.
 - b. Operator and remote battery level percentage displayed.
 - c. Solar charge rate displayed in mA.
 - d. Temperature display.
2. 9 programmable zones with up to 9 operators assigned per zone. Able to control up to 81 operators.
3. Automatic temperature control function.
4. Multiple remotes can be used on a Main / Secondary relationship. Pairing and settings can be sent from a main remote to secondary remotes wirelessly.
5. Stand-up base with wall mount option.
6. Remote uses standard (2) AA batteries.

SOLAR SMART REMOTE

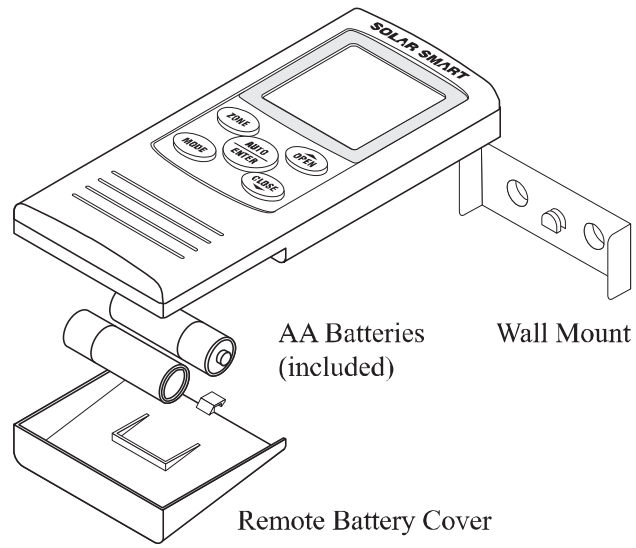

SOLAR SMART OPERATOR

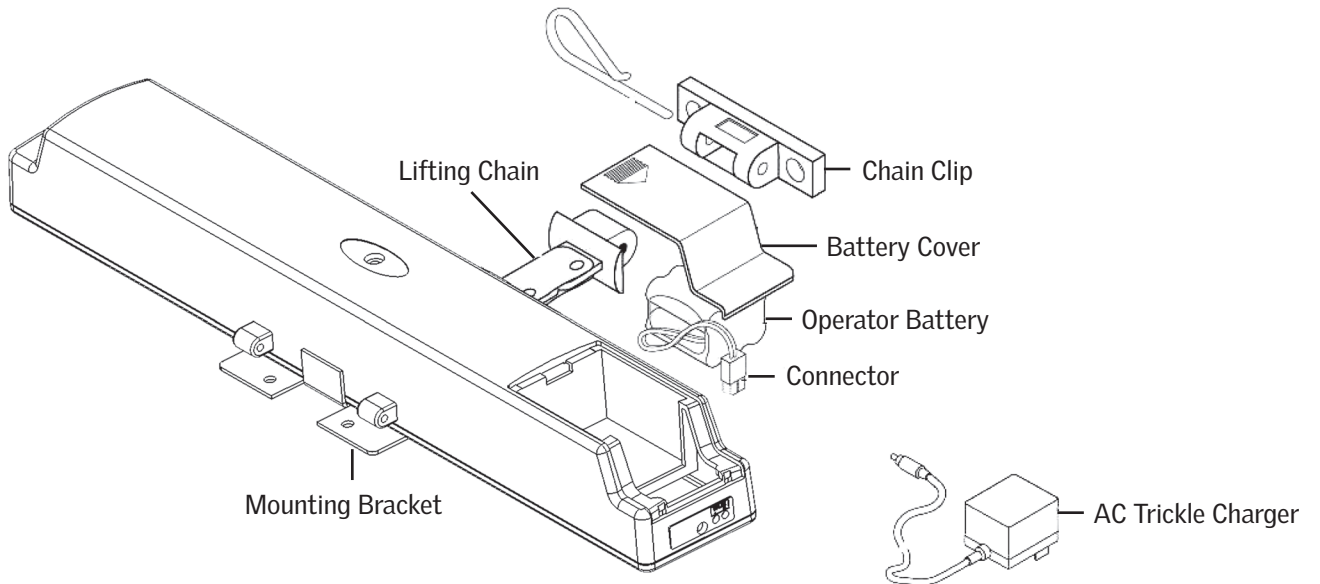

SOLAR SMART REMOTE

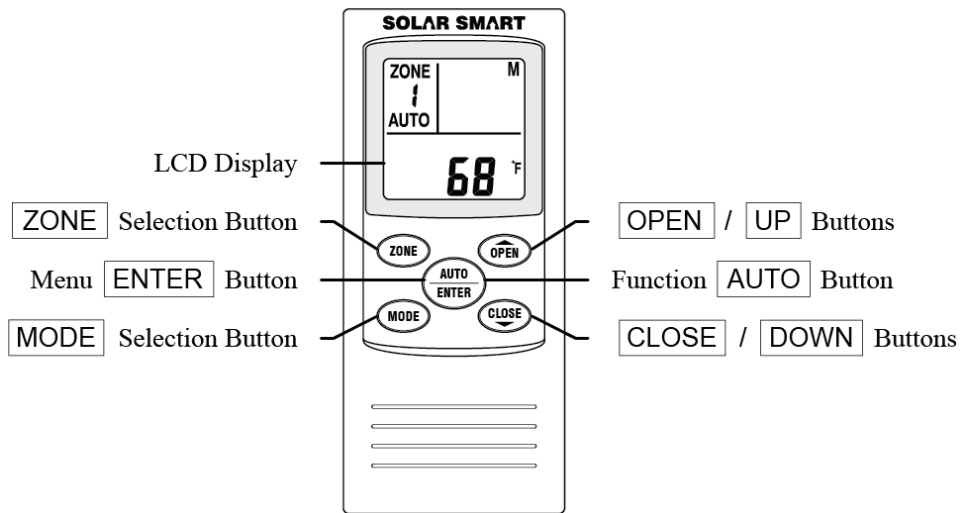

-
- Using the operator requires that it has been paired to the remote. Refer to Initial Remote Setup and Configuration.
-

Opening and Closing of an Operator

1. Press any key to wake up the remote, if the LCD display has powered off.
2. Press **ZONE** to choose a single zone (1 thru 9) of operators or **ALL** to operate all operators in all zones.
3. Press **OPEN** or **CLOSE** to open or close the window/skylight.
4. Press **OPEN** or **CLOSE** during operation to **STOP** the operator at any time.

Enable / Disable Automatic Functions

1. Press and hold **AUTO** to show or remove **AUTO** from the display, thus enabling or disabling the temperature control (TC) or Time-to-Close (P1) functions.

INITIAL REMOTE SETUP and CONFIGURATION

NOTE: The remote has been configured and paired by VELUX. Keep instructions for future use.

- The following are applicable for configuring the main remote only. To configure additional remotes, refer to 'Multiple Remotes' for more information.
- Pressing **MODE** does not work when zone in remote display is set to **ALL**. Press **ZONE** to exit zone **ALL**.
- All steps must be performed within 30 seconds or the remote control will default to the previous settings.

1. Open the remote battery cover and install the two AA alkaline batteries and replace the cover.
2. All the screen display segments will be visible while the remote runs a self-test which lasts for a few seconds. After which, **SET** will be displayed.
3. Press **▲▼** to choose either **C** (Celsius) or **F** (Fahrenheit).
4. Press **ENTER** to save your selection.
5. Press **▲▼** to choose either **M** (main) or **S** (secondary). Select **M** for main.
Note: Secondary is only used when using additional remotes. Refer to 'Multiple Remotes' for more information.
6. Press **ENTER** to save your selection.
7. **ZONE ALL** and the temperature should now be displayed.

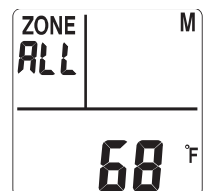
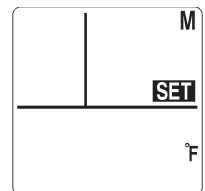
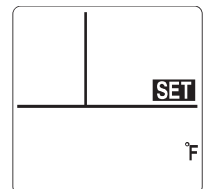
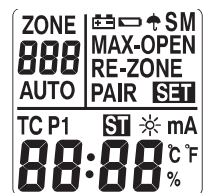

PAIRING the REMOTE to the OPERATOR

- Pairing sets up communication between the remote and the operator.
- The remote will be able to control all operators assigned within a single zone simultaneously, or control all zones at once.
- There are 9 zones (1 thru 9), with each zone containing 9 ID numbers (1 thru 9). Each operator will need to be assigned to a zone and ID number. Each zone and ID number combination can only be assigned one operator.
- The following instructions are applicable to pairing the first and additional operators to a single remote.
- Each operator can only be paired with one main remote, however multiple secondary remotes may be used once setup and configured.

The Operator

- The remote will need to be paired within 2 minutes, or the operator will default back to the previous settings.

1. Remove the battery cover from the operator. If connected, disconnect the battery connector from the operator circuit board, for at least 30 seconds.

NOTE: The Solar Panel must also be disconnected at this time.

2. Connect the battery connector to the operator circuit board, pressing firmly until the plug is locked into place.
3. The red light on the circuit board will continually blink while it is in pairing mode.

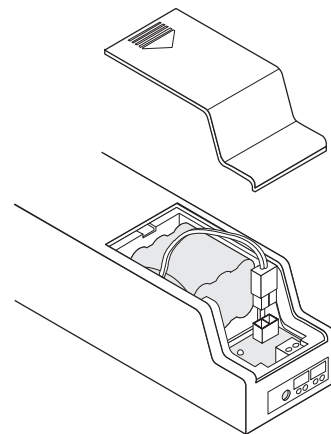

The Remote

1. Press any key to wake up the remote, if the display has powered off.
2. Press and hold the **MODE** key, release when **PAIR SET** is displayed.
3. Press **ZONE** as necessary to choose the appropriate zone (1 thru 9).
4. Press **ENTER** to save your selection.
5. Press **▲** **▼** to choose the ID number (1 thru 9) within the zone. ID numbers already in use will not be displayed.
6. Press **ENTER** to save your selection. The remote will attempt to pair to the operator.

(continues on next page)

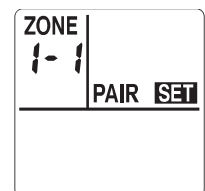
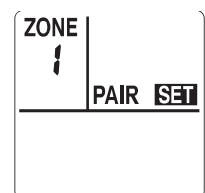

7. **SUCC** will be displayed to indicate a successful pairing. The operator will then fully open then close one cycle. **DO NOT** press any buttons on the remote until this cycle completes.
 - a. If a **FAIL** message is displayed, press **ENTER** on the remote to try to pair again.
 - b. If a **FAIL** message is displayed again, ensure that the operator is in pairing mode. If the red light is not still blinking, disconnect and reconnect the battery connector on the operator and repeat steps 1-7 again.

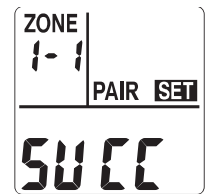

MULTIPLE REMOTES

- It is intended that one or multiple operators may be controlled from multiple secondary remotes. This is done by sending the pairing and settings stored in the first configured **M** (main) remote, to the additional **S** (secondary) remote(s). Secondary remotes will be 'copies' of the main.
- Any changes to operator zones, ID numbers, and/or adding additional operators can only be performed using the main remote. The changed settings would then need to be re-sent from the main to the secondary remote(s).
- Ensure that a main remote has been configured as outlined in 'Remote Setup and Configuration' and that it has been paired to the operator(s) as described in 'Pairing Remote to Operator.'

Secondary Remote Configuration

- All steps must be performed within 30 seconds or the remote control will default to the previous settings.

1. Open the remote battery cover; remove and reinstall two AA alkaline batteries and replace the cover.
2. All the screen display segments will be visible while the remote runs a self-test which lasts for a few seconds. After which, **SET** will be shown on the Display to indicate input is required.
3. Press **▲▼** to choose either **C** (Celsius) or **F** (Fahrenheit).
4. Press **ENTER** to save your selection.
5. Press **▲▼** to choose either **M** (main) or **S** (secondary). Select **S** for secondary.
6. Press **ENTER** to save your selection.
7. **ZONE ALL** and the temperature should now be displayed.

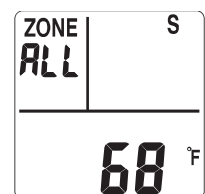
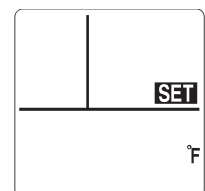

1. SECONDARY REMOTE STEPS

- a. Press and hold **MODE**, release when **PAIR SET** is displayed and the **S** in the upper-right corner is flashing.
- b. Press **ENTER**. The secondary remote will now be waiting to receive the transmission from the main remote. It will wait for 30 seconds.

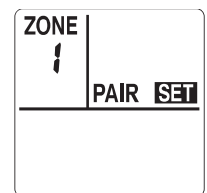
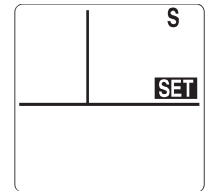
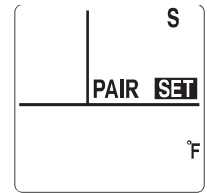

2. MAIN REMOTE STEPS

- a. Press and hold **MODE**, release when **PAIR SET** is displayed.
- b. Press **MODE** twice to move past **RE-ZONE** to display **M** in the upper-right corner as flashing.
- c. Press **ENTER** to begin transmitting the settings to the secondary remote.
- d. **SUCC** will be displayed on a successful transfer of settings.
 - i. If a **FAIL** message is displayed instead, be sure that the secondary remote is still configured to be waiting to receive the transmission. Press **ENTER** to retry.

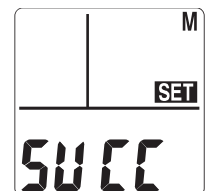
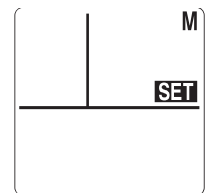

RAIN SENSOR

The rain sensor should be installed horizontally, with a slight tilt to prevent water from pooling. The sensor location depends on many factors. The key to proper installation is that the sensor must be **level and exposed** when the operator opens the unit. The wires from the sensor to the operator must be ran to the operator in a water proof manner so as to not induce water penetration that could damage the interior. The sensor is not polarity sensitive so it does not matter which wire goes to which connector in the operator.

By default, the rain sensor is enabled when the remote is initially paired to the operator regardless of whether the rain sensor is attached or not. When the rain sensor is enabled a small ☂ umbrella will be displayed in the top right hand display box.

1. To enable or disable the rain sensor, press any key to wake up the remote if the LCD display has powered off.
2. Press **MODE**.
3. Press **ZONE** as necessary to choose the desired zone.
4. After the desired zone is flashing, press **ENTER**.
5. **MAX-OPEN** will know be flashing.
6. Press **▲▼** until the ☂ icon is displayed and flashing, press **ENTER**.
7. Press **▲▼** to choose the ID number (1 thru 9) within the zone.
8. Press **ENTER** to confirm your selection.
9. Press **▲▼** to choose between **ON** and **OFF** while they are flashing.
10. Press **ENTER** to save your setting.
11. LCD displays steady **ON** or **OFF** for one second, then **SUCC** for 2 seconds, indicating success. Press **MODE** a few times to return to the home screen
 - a. If setting not successful, LCD displays **FAIL** for 1 second, then returns to the same step #8 to retry setting.

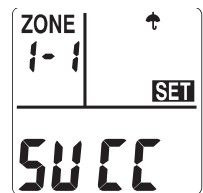
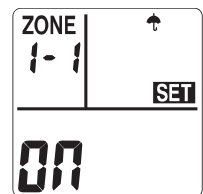
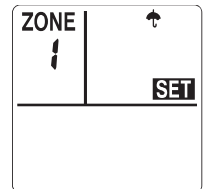

RAIN SENSOR OPERATION

When a drop of water is on the sensor the operator may not react immediately. The control system actually takes multiple reading in an effort to avoid false readings and possible “cycling” of the operator before it sends the close or open commands.

If the operator is manually opened when the rain sensor is enabled AND there is water present on the sensor, the operator will close and the ☂ umbrella icon will blink on the Remote. If you desire to open the operator at this time, the sensor will need to be disabled before it will stay in the open position.

If the Rain Sensor and the Automated Temperature Control are enabled at the same time, the Rain Sensor will take precedence over the Temperature Control. In other words, if rain is detected, the operator will close regardless of the temperature until such time as water is no longer detected on the sensor before it will automatically re-open.

As noted above, the rain sensor is designed to detect a lowering of the resistance between the metallic strips on the sensor. The resistance can be lowered by a number of factors including moss, sap, heavy dew, or condensation drops from surrounding structures. Therefore it is important to periodically clean the sensor to maintain proper operation. If all operations function properly except when the Rain Sensor is enabled, cleaning the Rain Sensor is recommended.

TIME TO CLOSE

The Time to Close (**P1**) function will automatically close the operator after a user defined time period. The user selected time period is in 10 minute increments from 0 to 1 hour. From 1 to 24 hours, the increments change to 30 minutes.

1. Press any key to wake up remote, if the LCD display has powered off.
2. Press **MODE** - the LCD should display **SET**, and **ZONE** should be flashing.
3. Press **ZONE** as necessary to choose the appropriate zone (1-9).
4. When the correct zone is flashing, press **ENTER**
5. **MAX-OPEN** will be displayed and flashing.
6. Press **▲▼** until **P1** is displayed and flashing.
7. Press **ENTER**.
8. Press **▲▼** until the desired Time To Close is displayed and flashing or **NULL** to turn function off.
9. Press **ENTER**.
10. **ST** is now displayed and flashing. Press **MODE** to return to the home screen OR press **▲▼** to scroll and set other features.
11. The Time To Close selection will be retained in memory until changed by the user. However, you must activate the **AUTO** feature for either the Time To Close or the Temperature Control (TC) function for it to operate. NOTE: The Time To Close and Temperature Control cannot be enabled simultaneously for the same zone.

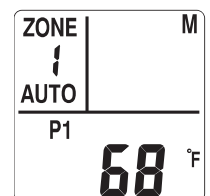
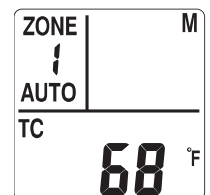
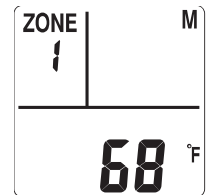
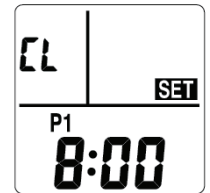
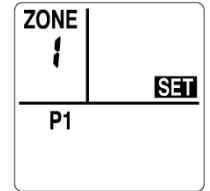

Enable / Disable the TIME TO CLOSE Function

1. To activate the **AUTO** function you must start in the Home screen.
2. Press and hold the **AUTO** button for 2 seconds until the screen changes. The screen will read either **AUTO/TC**, **AUTO/P1**, or be blank which disables both automatic functions. Each time you press and hold the **AUTO** button for 2 seconds it will scroll the screen to the next option. When the correct Auto Function is displayed, you are done.
3. When the Auto function is enabled, it will stay enabled until it is turned off.

SETTING MAX-OPEN LIMIT

- The travel distance that the operator(s) will open a window/skylight (**MAX-OPEN**) can be reduced for all operators within a zone; and each zone may have a unique **MAX-OPEN** value. This may be beneficial to prevent rain or excess wind from entering when the operator(s) is open.
- The factory setting **MAX-OPEN** limit is set to open up to 80% of full open position.

1. Press any key to wake up the remote, if the LCD display has powered off.
2. Press **MODE**.
3. Press **ZONE** as necessary to choose the appropriate zone 1 thru 9.
4. Press **ENTER** to save your selection.
5. **MAX-OPEN** will be displayed and flashing.
6. Press **ENTER**.
7. Press **▲**/**▼** to set the percentage, in increments of 10%.
8. Press **ENTER** to save your setting.
9. **TC** is now displayed.
10. Press **MODE** to return to the home screen - OR - to continue on to set the Temperature Control (TC).

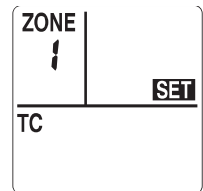
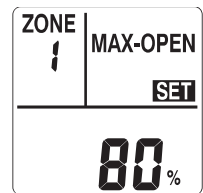
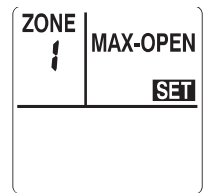
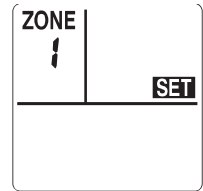

SETTING TEMPERATURE CONTROL (TC)

- Automated temperature control (TC) can be set for all operators within a zone; and each zone may have a unique TC value.
- When set and the remote is set to **AUTO**, the temperature control will open the operator(s) within a zone when the temperature setting is reached.
- It will close the operator(s) when the temperature drops greater than 5 degrees (F) or 2 degrees (C) below the set level.
- This automatic function is based on the temperature at the remotes location and must be maintained for approximately 5 minutes.

- Press any key to wake up the remote, if the LCD display has powered off.
- Press **MODE**.
- Press **ZONE** as necessary to choose the appropriate zone (1 thru 9).
- Press **ENTER** to save your selection.
- MAX-OPEN** will be displayed and flashing.
- Press **▲▼** until **TC** is displayed and flashing.
- Press **ENTER**.
- Press **▲▼** to set the desired temperature, or **NULL** to turn function off, for this zone.
- Press **ENTER** to save your selection.

- The temperature in which the operator will run has now been set. Next, a **MAX-OPEN** limit is set specifically for when the TC function opens the operator. This **MAX-OPEN** cannot exceed the limit set for basic operation.

- Press **▲▼** to set the percentage, in increments of 10%, of the temperature controlled **MAX-OPEN**. Operator(s) will not open past **MAX-OPEN** set above. Press **ENTER** to save your setting.
- P1** is now displayed.
- Press **MODE** to return to the home screen - OR - to continue on to check the status of the batteries and charge current.

- After any change to the TC settings, the TC function will be enabled and **AUTO** will be displayed.

Enable / Disable the TC Function

- Press and hold the **AUTO** button for 2 seconds until the screen changes. The screen will read either **AUTO/TC**, **AUTO/P1**, or be blank which disables both automatic functions. Each time you press and hold the **AUTO** button for 2 seconds it will scroll the screen to the next option. When the correct Auto Function is displayed, you are done.

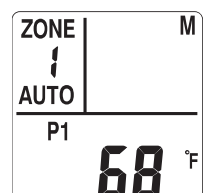
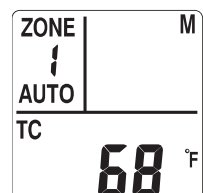
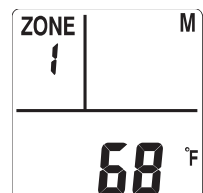
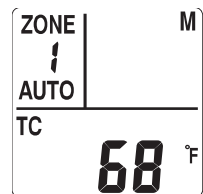
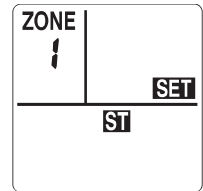
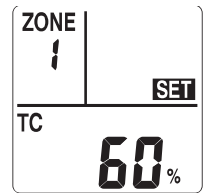
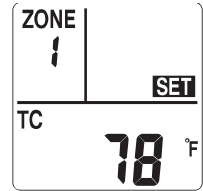
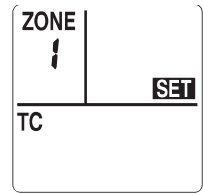

CHECKING STATUS OF BATTERIES AND CHARGING CURRENT

1. Press any key to wake up the remote, if the LCD display has powered off.
2. Press **MODE**.
3. Press **ZONE** as necessary to choose the appropriate zone (1 thru 9).
4. Press **ENTER** to save your selection.
5. **MAX-OPEN** will be displayed and flashing.
6. Press **▲▼** until **ST** is displayed and flashing.
7. Press **ENTER**.
8. Press **▲▼** to choose the ID number (1 thru 9) of the operator within the zone.
9. Press **ENTER** to save your selection.
10. Press **▲▼** to cycle viewing either the solar charging rate in mA, operator battery status, or the remote battery.
 - Solar charging rate is measured in Milliampere (mA). Refer below for more information on charging rate.
11. Press **MODE** to return to main screen.

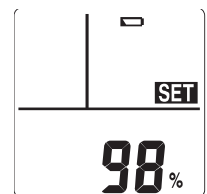
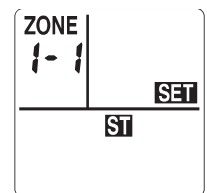
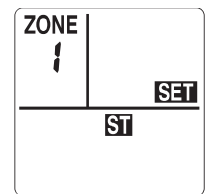
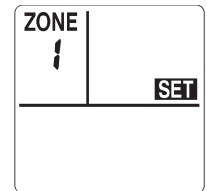
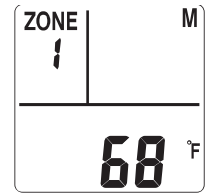

Remote Battery Status

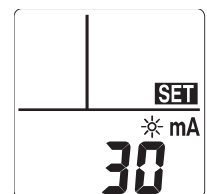

Solar Charging Rate

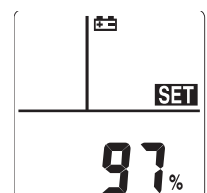



Operator Battery Status

Charging Rate

- mA is the abbreviation for Milliampere, which is a unit of electrical current flow. In this case, it is the measurement of current into the battery when charging, and it will range between 0 and 150 mA.
- The charging measurement is taken each time the status is requested and is a 'snap shot' of the conditions at that particular moment in time.
- This measurement is highly variable and depends directly upon the level of sunlight on the solar panel. Be aware of external influences which affect the light level, these are: direction and angle of exposure of the solar panel to the light source, sky conditions, clouds, man-made structures or trees which cause shadows on all or part of the solar panel, and maintenance of the solar panel itself, to keep it clean.
- Current flow is also highly dependent upon the battery state of charge and the status measurement may report zero or low mA, even when solar and all other conditions are optimum. For example, the solar panel could be outputting 40 mA on a battery that has a low charge, however on a battery with near full charge the output may only be 10 mA.
- Solar Smart limits the maximum charge current for safety reasons, to extend battery life, and to prevent over-charging damage to the battery.

Battery Alerts

- The  icon will be displayed on the remote when the remote batteries are in need of replacement.
- The  icon will be displayed when the operator battery is low. When the operator battery is critically low, the operator will be allowed to close; however will not be able to open until the battery is recharged to a sufficient level.

RE-ZONING

- Recommended only for when multiple operators are used with a single remote.
- This process removes the operator from the assigned zone and/or ID number, but remains paired to the remote. The operator then is reassigned to a new zone and/or ID number on the same remote.
- **CAUTION - If this is not done correctly, you will have to re-pair the Remote to the Operator, which would involve unplugging the Operator's battery. Please read these instructions carefully first, before performing this operation.**

1. Press any key to wake up the remote, if the display has powered off.
2. Press and hold **MODE**, release when **PAIR SET** is displayed.
3. Press **MODE** again to display **RE-ZONE**.
4. Press **ZONE** as necessary to choose the appropriate zone (**1** thru **9**) of the operator to be moved to another zone.
5. Press **ENTER** to save your selection.
6. Press **▲▼** to choose the ID number (**1** thru **9**) within the zone in which the operator is assigned to.
7. Press **ENTER** to save your selection.
8. **SUCC** will be displayed. The operator will now be unassigned from the previous zone and ID number. **DO NOT STOP HERE, steps 8, 9 and 10 must be completed.**
 - a. Press **ENTER** to retry, if a **FAIL** message is displayed instead.
9. Press **ZONE** to choose the new zone (**1** thru **9**) the operator shall be assigned to.
10. Press **ENTER** to save your selection.
11. Press **▲▼** to choose the ID number (**1** thru **9**) within the zone in which the operator shall be reassigned to.
12. Press **ENTER** to save your selection.
13. **SUCC** will be displayed. The Operator will run through an entire open and close cycle.

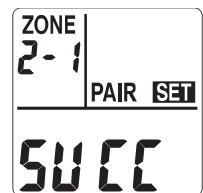
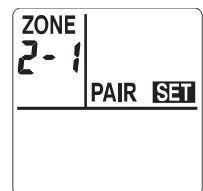
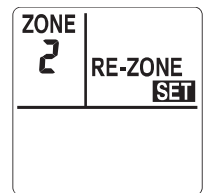
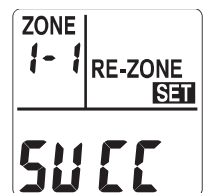
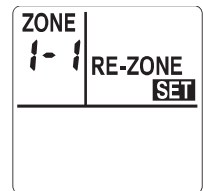
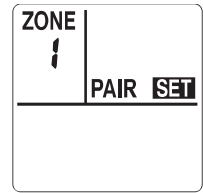

REMOTE DISPLAY

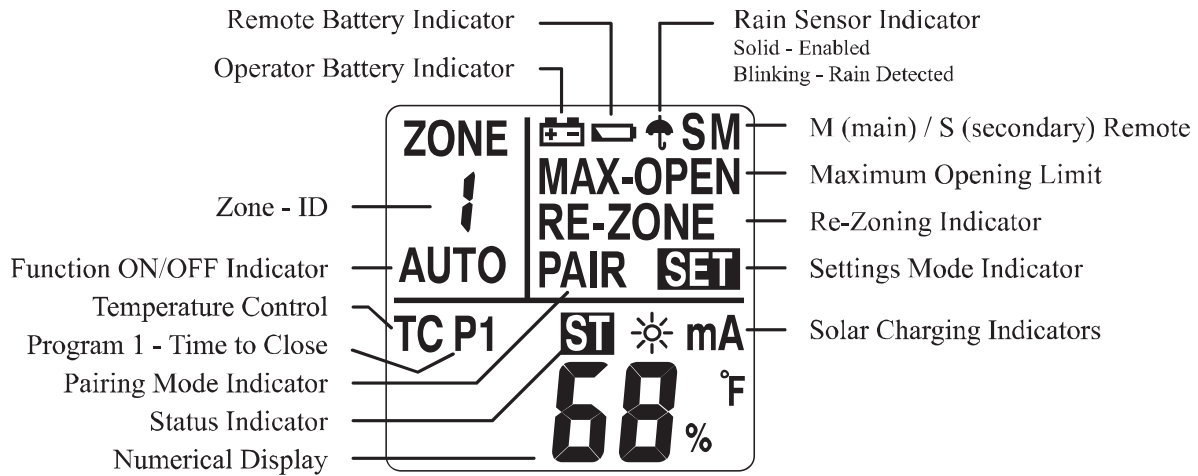

TROUBLESHOOTING TIPS

1. If in **AUTO** mode and operator(s) is not working as expected, make sure none of the secondary remotes are set to **AUTO** mode and that temperature control (**TC**) for all zones on secondary remotes are set to **NULL**.
2. **MAX-OPEN** can be set to different values on both the main and secondary remotes. The operator will open to the **MAX-OPEN** setting of the remote used to open it. If the operator is not opening the proper amount be sure to check that **MAX-OPEN** is set properly on the remote used.
3. Temperature control (**TC**) may also have to be set to have a lower **MAX-OPEN** value than the otherwise set **MAX-OPEN**.
4. Temperature change must be maintained for 10 minutes before the temperature control (**TC**) function will operate.

For more Trouble Shooting Tips, please visit www.SolarSmartOpener.com

ADVANCED SERVICE OPERATIONS

RESET OF REMOTE TO FACTORY SETTINGS

1. Press any key to wake up the remote, if the display has powered off.
2. Press and hold **MODE**, release when **PAIR SET** is displayed.
3. Press **MODE** again to display **RE-ZONE**.
4. Press **MODE** to display **M** in the upper-right corner as flashing.
5. Press **ENTER** **FAIL** is displayed as flashing.
6. Press and hold **MODE**, release when **rF TEST** is displayed.
7. Press **MODE** repeatedly until **rET FAC** is displayed.
8. Press **ENTER**, all the screen display segments will be visible while the remote runs a self-test which lasts for a few seconds. After which, **SET** will be displayed.

The remote has now been reset to factory settings; it is no longer paired to any operators.

Please record your Remote settings for ease of reference as well as assist in troubleshooting.

ZONE	ID	Location
1	1	
	2	
	3	
	4	
	5	
	6	
	7	
	8	
	9	
2	1	
	2	
	3	
	4	
	5	
	6	
	7	
	8	
	9	
3	1	
	2	
	3	
	4	
	5	
	6	
	7	
	8	
	9	
4	1	
	2	
	3	
	4	
	5	
	6	
	7	
	8	
	9	
5	1	
	2	
	3	
	4	
	5	
	6	
	7	
	8	
	9	

ZONE	ID	Location
6	1	
	2	
	3	
	4	
	5	
	6	
	7	
	8	
	9	
7	1	
	2	
	3	
	4	
	5	
	6	
	7	
	8	
	9	
8	1	
	2	
	3	
	4	
	5	
	6	
	7	
	8	
	9	
9	1	
	2	
	3	
	4	
	5	
	6	
	7	
	8	
	9	